

PLIAGE DE PAPIER

une rubrique proposée par Francis Bothner

BEC

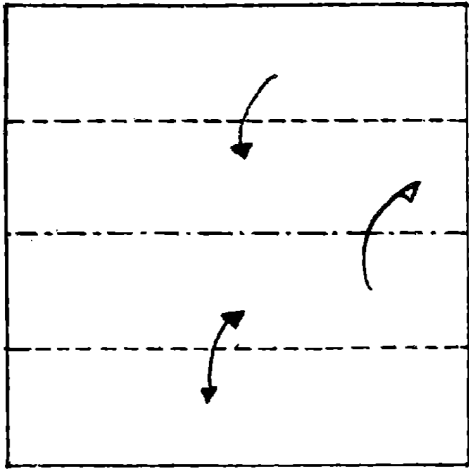

} plier

marquer

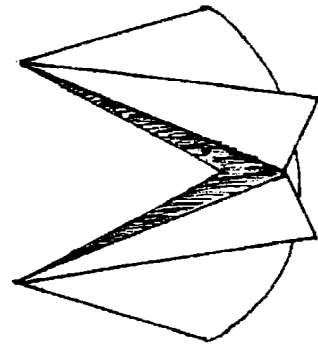
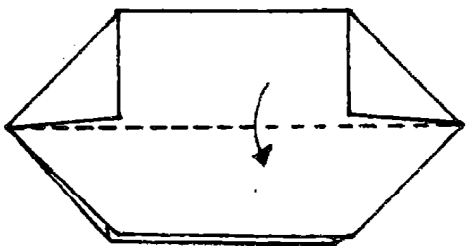
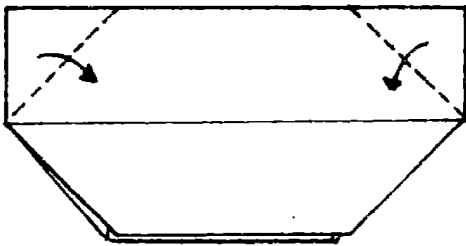
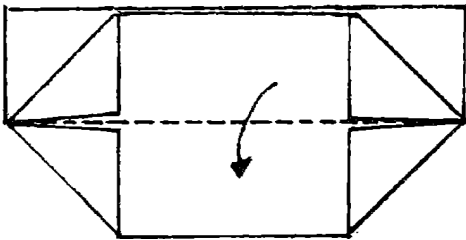
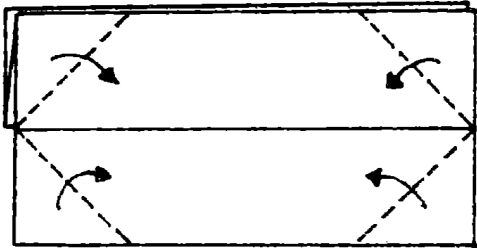

rapprocher A et B

ouvrir

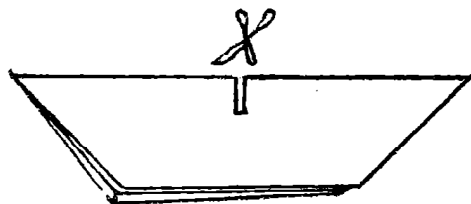
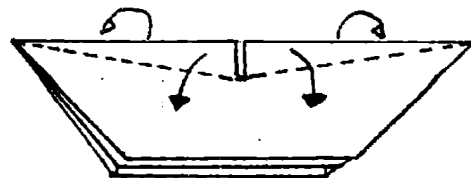
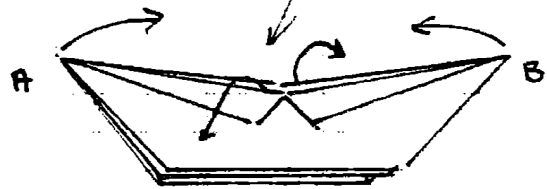

cocotte

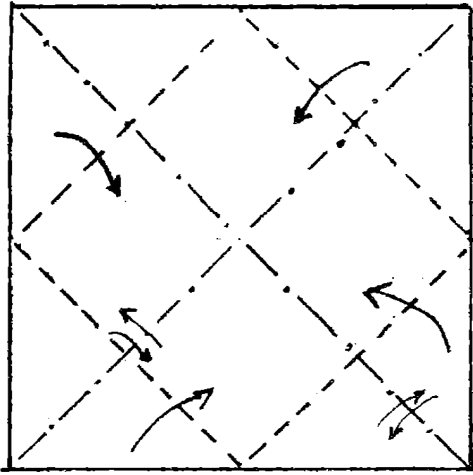

- marquer les diagonales.
- replier →
- retourner la feuille

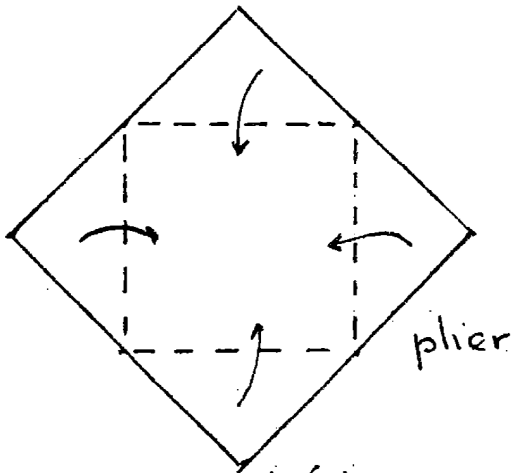

plier

déplier sans retourner

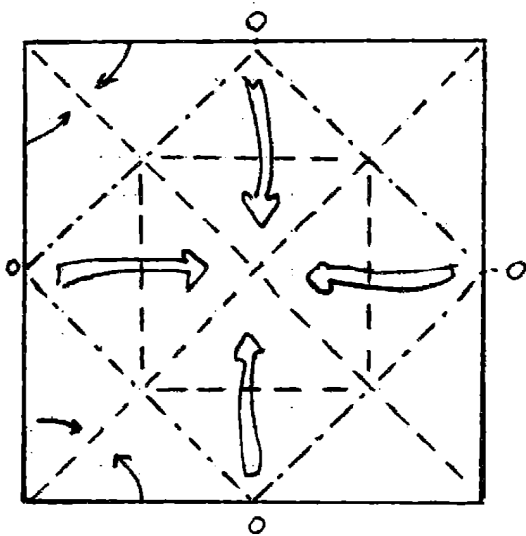

ramener les 4 milieux "o" sur le centre

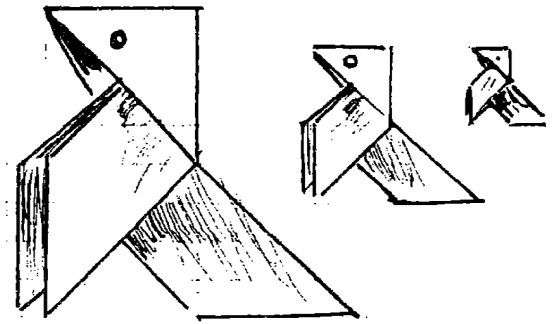

pli retourné

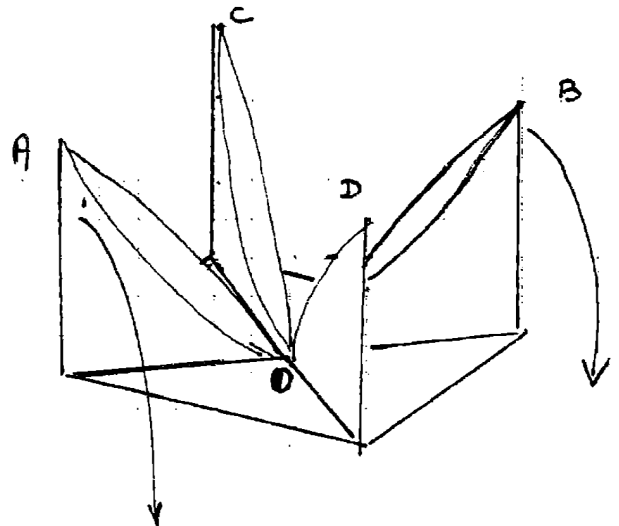
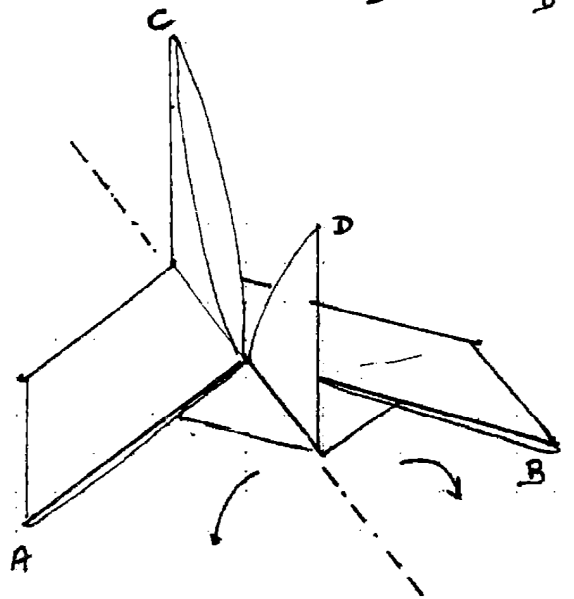
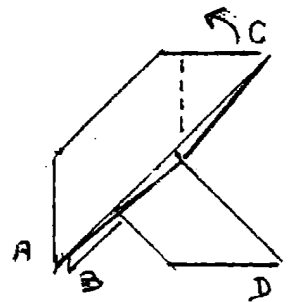

poisson

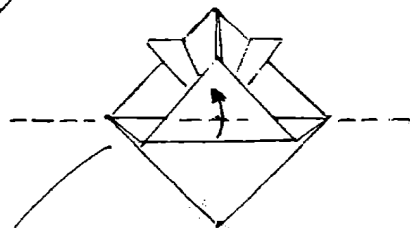
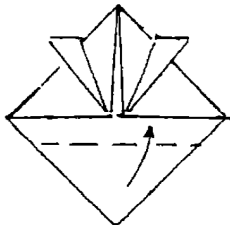
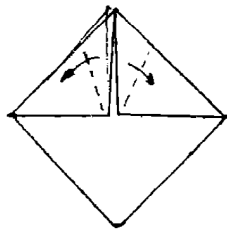
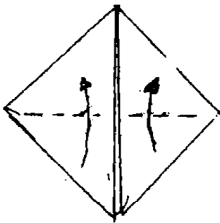
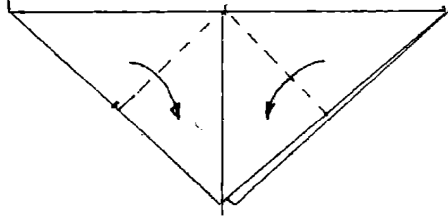
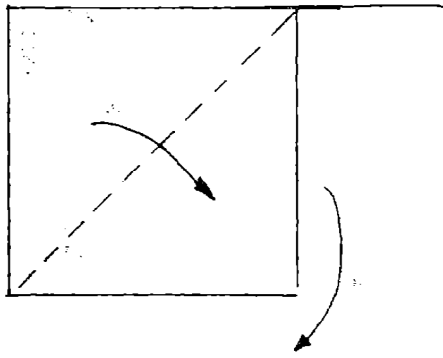

agrandi

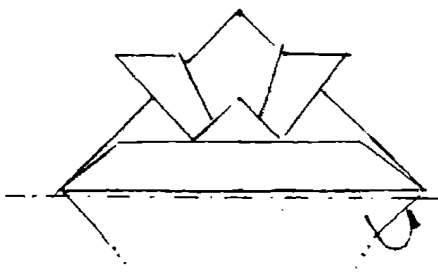

vers l'arrière

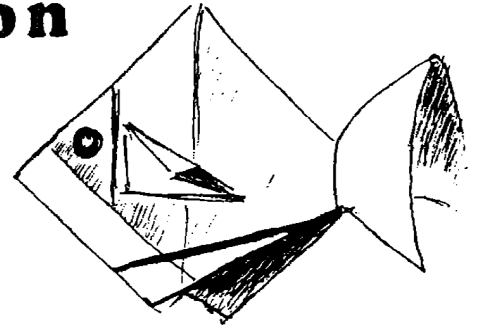

nageoire
à
angle
droit

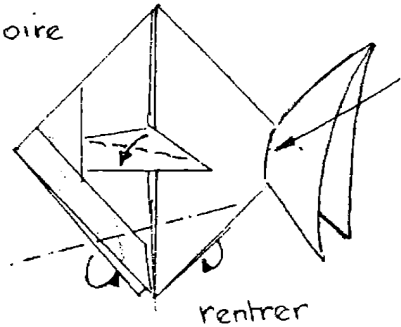

appuyer
le pli

rentrer

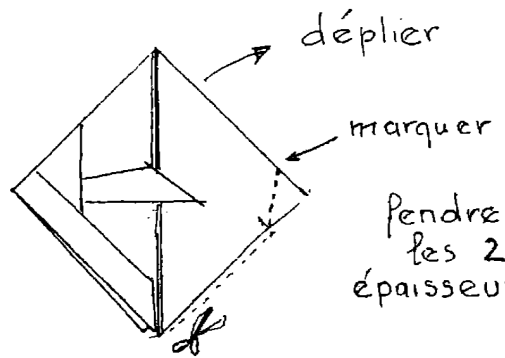

déplier

marquer

pendre
les 2
épaisseurs

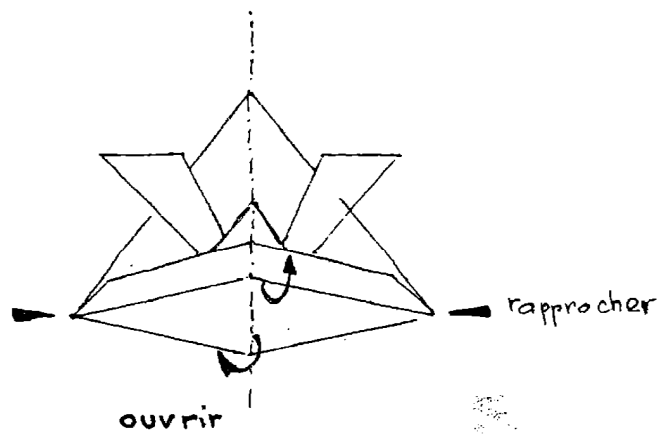

ouvrir

rapprocher